

# COOPER B-LINE

509 W. Monroe Street • Highland, IL 62249  
 Phone: 618-654-2184 • Fax: 618-654-1917



## Basic Channel 1 5/8" Wide Sections, Combinations & Hole Patterns

<b>B11</b> 3 1/4" Tall 12 Ga.	<b>B12</b> 2 7/16" Tall 12 Ga.	<b>B22</b> 1 5/8" Tall 12 Ga. 14 Ga. 16 Ga.	<b>B32</b> 1 3/8" Tall 12 Ga.	<b>B52</b> 1 3/16" Tall 12 Ga. 14 Ga. 16 Ga.	<b>A Channel</b>	<b>X Channel</b>
<b>SH Channel</b> 9/16" x 7/8" slots 2" on centers	<b>B22TH Channel</b> 9/16" holes 1 7/8" on centers	<b>H1 7/8 Channel</b> 9/16" holes 1 7/8" on centers	<b>KO6 Channel</b> 7/8" dia. knockout 6" on centers	<b>S Channel</b> 1 3/32" x 3" slots 4" on centers		

Plain Channel   
  Dura-Green Channel   
  Pre-Galvanized Channel   
  HDGAF Channel  
 Special Painted Channel   
  PVC Coated Channel   
  Aluminum Channel

### General Information (Channel & Fittings)

**Applications:** B-Line Systems channel is a basic structural member of the channel framing system. Use of the channel along with the appropriate fittings and attachments permit the rapid and economical construction of a virtually unlimited variety of rigid metal support structures. Channel sections are roll formed from strip steel coils while fittings are made from either steel coils or sheet. Refer to page 15 of the B-Line Strut Systems catalog for Channel Selection Table, pages 16-37 for Channel Load Data and pages 4-13 for Technical Data. Other sizing charts for conduit, pipe and tubing as well as threaded rod load charts are shown on pages 207-211 of the Strut Systems catalog.

**Materials:** B-Line's standard roll formed channels are made from Pre-Galvanized steel conforming to ASTM A653 SS, Grade 33 G90 (.45 oz. zinc/ft.<sup>2</sup>). Plain finish channels are roll formed from hot-rolled, pickled and oiled steel conforming to ASTM A570, Grade 33. Certain sections are available in Stainless Steel Type 304 & 316 (consult factory). Aluminum alloy 6063-T6 is used to extrude several channel sections and combination sections (consult factory).

**Finishes:** B-Line's standard finishes on channels are Dura-Green Epoxy and Pre-Galvanized (as shown above) while standard finishes for fittings are Dura-Green Epoxy and Zinc Plated. Plain finish is also available. (HDGAF) Hot-Dipped Galvanized After Fabrication is available on both channel and fittings (not recommended on threaded items) and conforms to one of the following applicable specifications: ASTM A123 or ASTM A153. Electro Galvanized Zinc (ZNPLT), ASTM B633, is available on most fittings and can be placed on channels per customer order. PVC coated and special paint colors are available on both channel and fittings per customer order (please consult factory).

See B-Line's Strut Systems (SS99) and Pipe Hangers & Supports (PH-00) Engineering Catalogs for more product information.

Many products comply with the following:  
 Manufacturers Standardization Society Specifications MSS-SP-58 and MSS-SP-69.  
 Federal Specification WW-H-171e.  
 Underwriters Laboratories Surface Metal Raceways.  
 ASTM B633.  
 ASTM A653 SS, Grade 33 G90  
 ASTM A570, Grade 33

## Channel Nuts & Hardware

<b>TN Series</b>	<b>N Series</b>	<b>NWO Series</b>	<b>STN Series</b>	<b>EZ Twirl</b>
<b>HHCS Series</b>	<b>LW Series</b>	<b>FW Series</b>	<b>HN Series</b>	<b>B655, B656</b>
				<b>ATR Series</b>

## Strut Fittings

<b>B202D</b>	<b>B129</b>	<b>B141</b>	<b>B341</b>	<b>B133</b>	<b>B132</b>
<b>B101</b>	<b>B102</b>	<b>B104</b>	<b>B844W</b>	<b>B147-B152</b> <b>B154</b> <b>B162-B165</b>	<b>B155-B161</b>
<b>B107-22A</b>	<b>B107</b>	<b>B261 Series</b>	<b>B110</b>	<b>B124</b>	
<b>B105</b>	<b>B119</b>	<b>B272</b>	<b>B172</b>	<b>B168</b>	

# COOPER B-LINE

509 W. Monroe Street • Highland, IL 62249  
 Phone: 618-654-2184 • Fax: 618-654-1917



## Strut Fittings

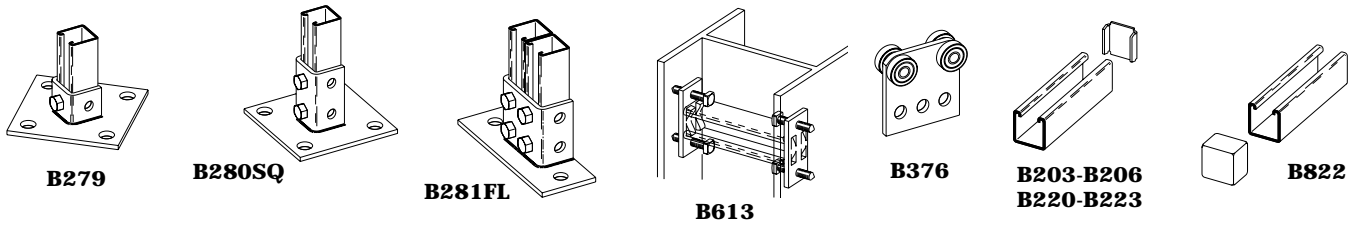

## Brackets

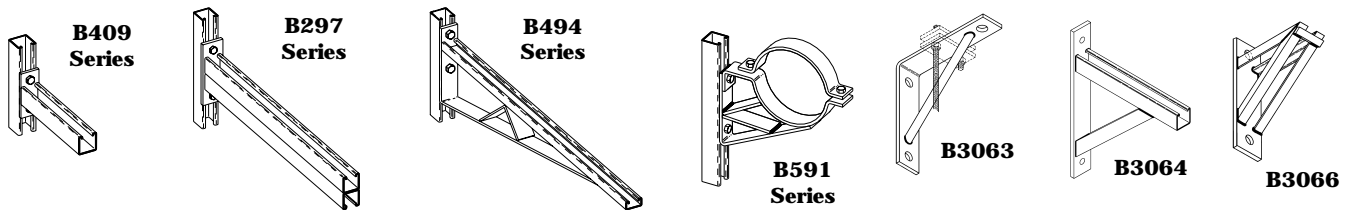

## Concrete Inserts - Continuous & Spot

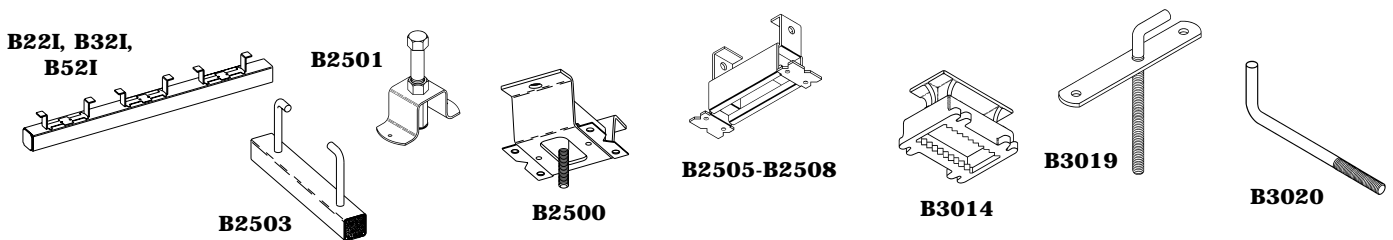

## Beam Clamps

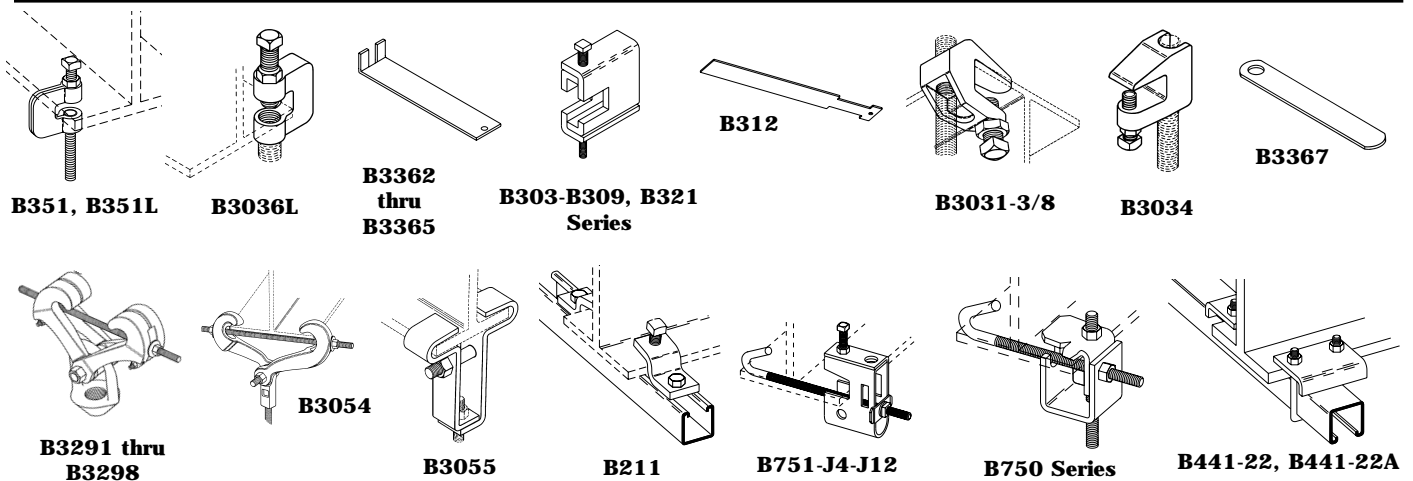

## Upper Attachments

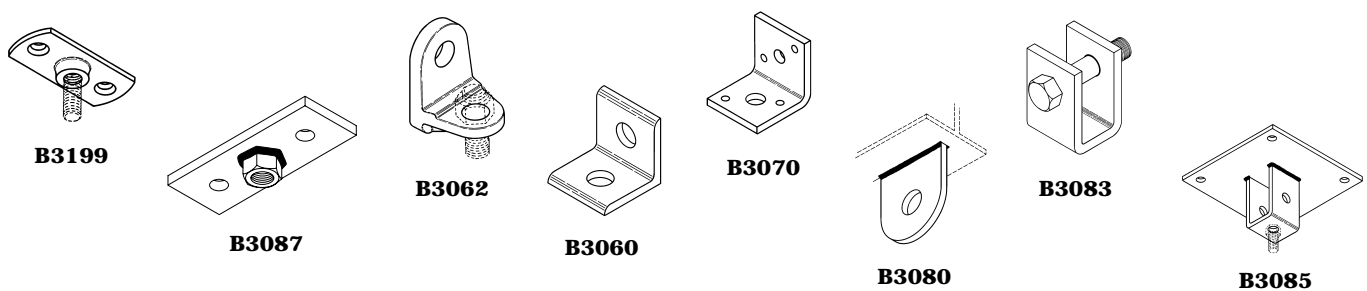

# COOPER B-LINE

509 W. Monroe Street • Highland, IL 62249  
 Phone: 618-654-2184 • Fax: 618-654-1917



## Pipe Clamps & Hangers

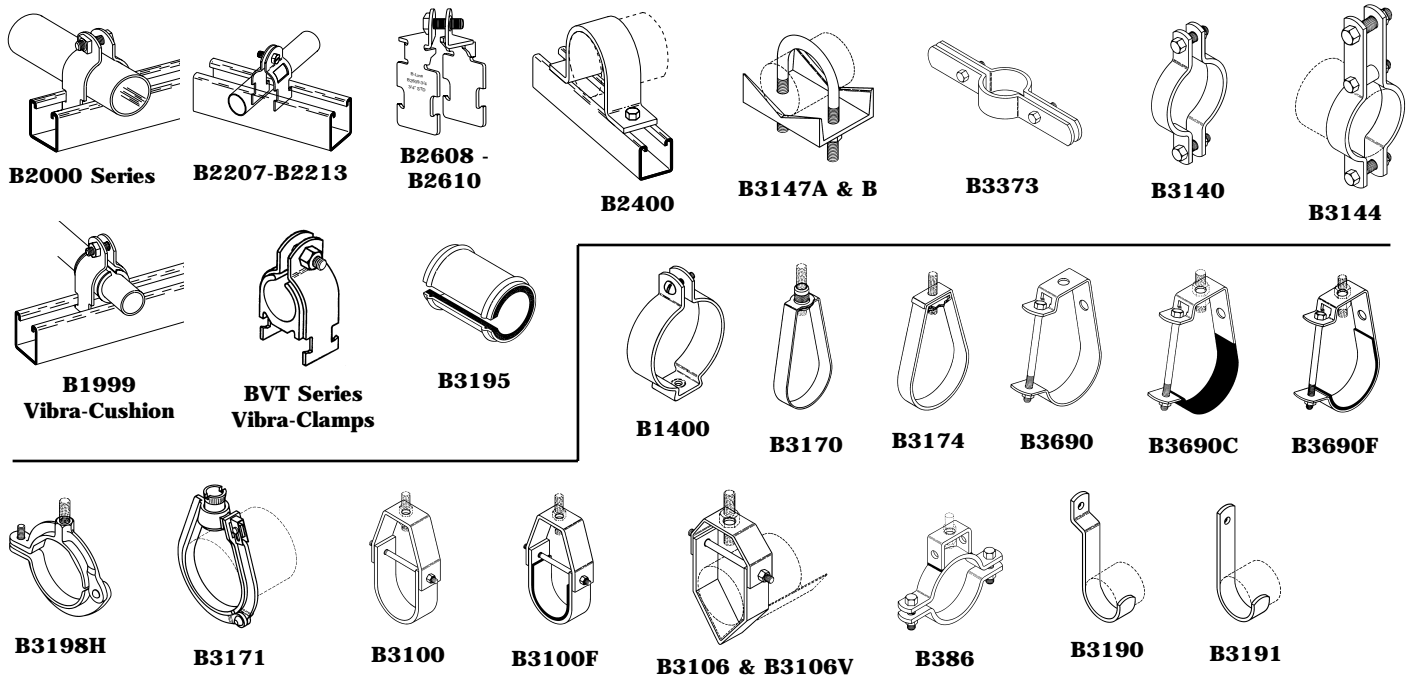

## Rollers, Guides & Saddles

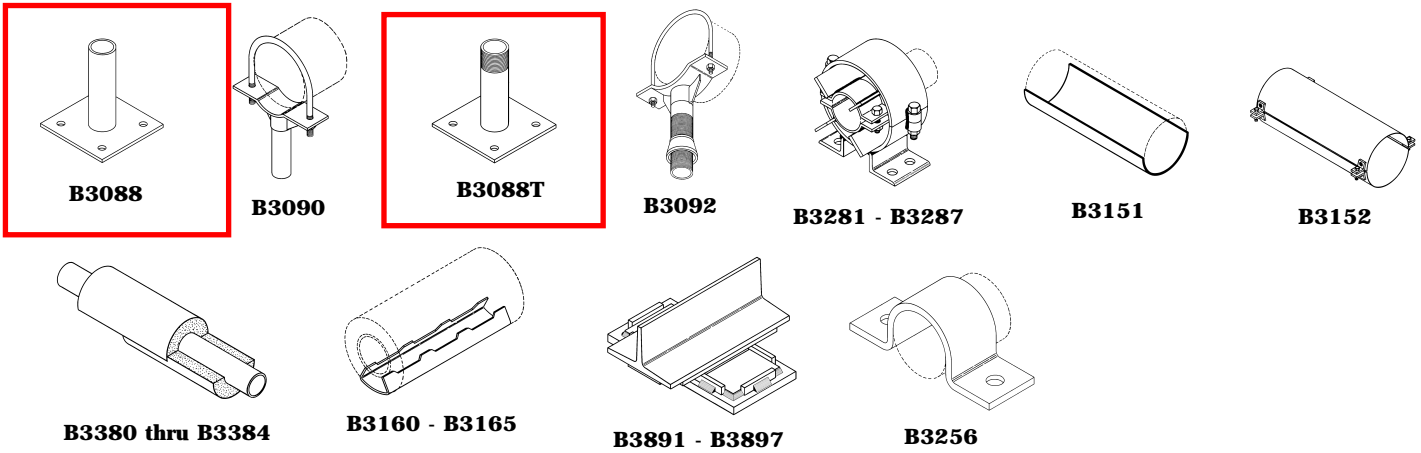
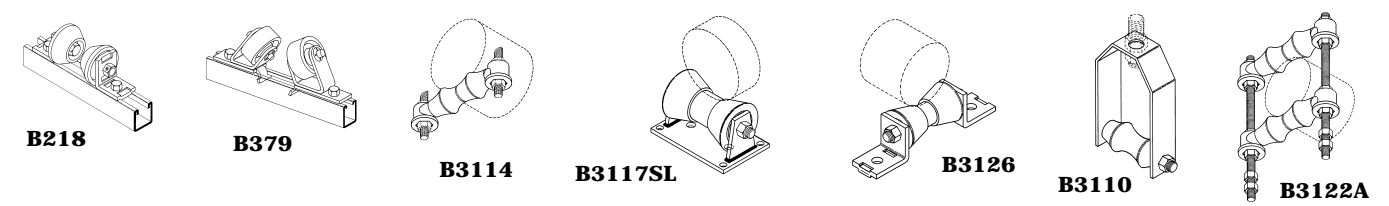

## Seismic Fittings

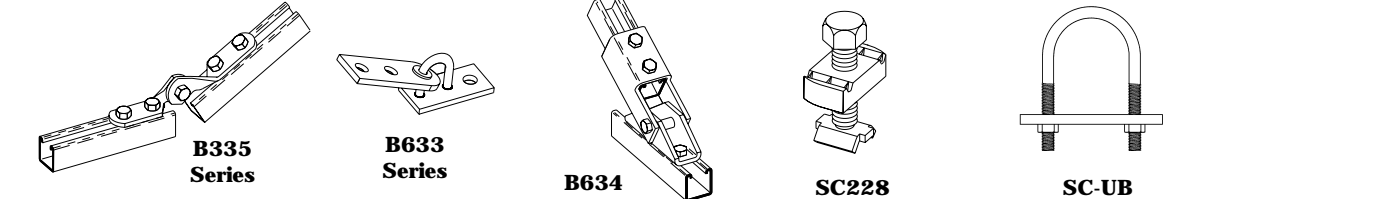

# COOPER B-LINE

509 W. Monroe Street • Highland, IL 62249  
 Phone: 618-654-2184 • Fax: 618-654-1917



## Pipe Hangers & Supports

### Accessories

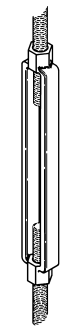

**B3202**

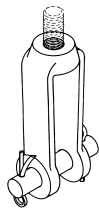

**B3201**

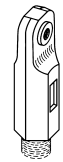

**B3203**

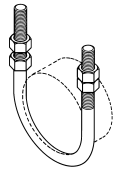

**B3188**

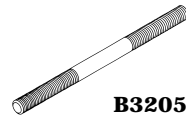

**B3205**

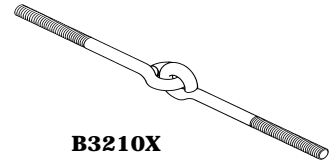

**B3210X**

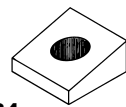

**B3234**

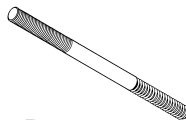

**B3213**



**B3200**



**B3223**

### Electrical Accessories

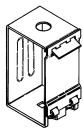

**B616 Series**

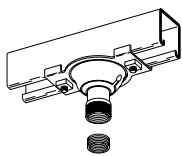

**B390S**

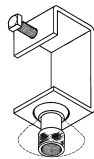

**B465**

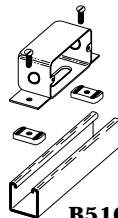

**B516S**

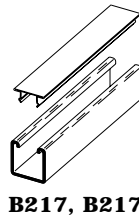

**B217, B217P**

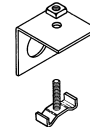

**B392 Series**

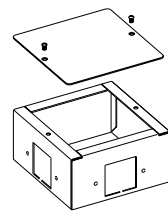

**B718**

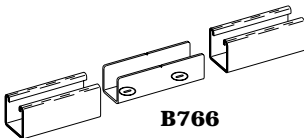

**B766**

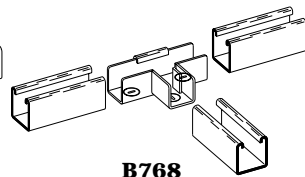

**B768**

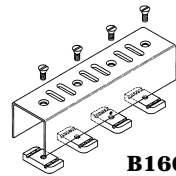

**B166 Series**

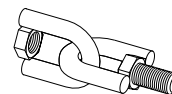

**B446 Series**

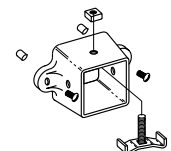

**B719**

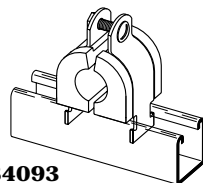

**B4060 thru B4093  
Porcelain Clamps**

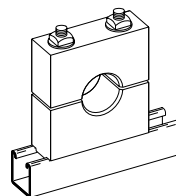

**B4033 Series  
Maple Clamps**

### VibraTrol™ Accessories

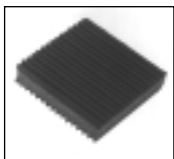

**CNP**



**VRP**



**ANH**



**HMLT/HMT**



**HMLE/HME**

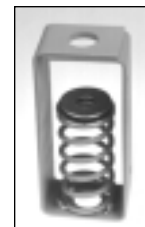

**HSL/HS**



**HESL/HES**