

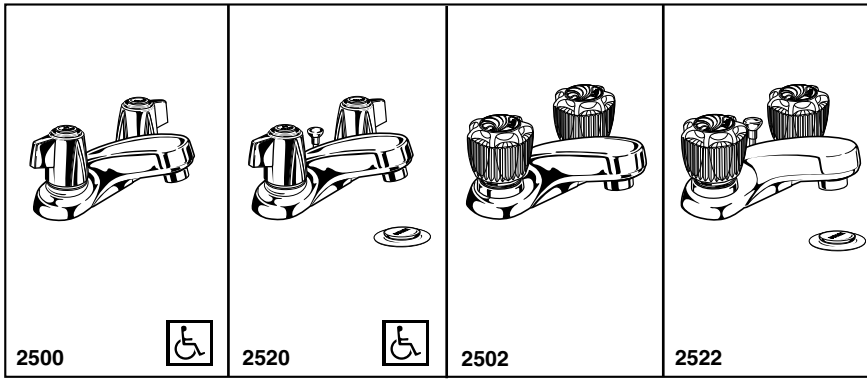

LAVATORY FAUCETS

- Two Handle
- 2 and 3 Hole Sink Applications
- 4" Centerset



Submitted Model No.: _____

Specific Features: _____



LISTED
UL Listed to US and Canadian
Safety Standards and Classified
In accordance with
ANSI/NSF 61D
21PL



COMPLIES WITH:

- ASME A112.18.1M-1996
- CSA B125-93
- Indicates ADA compliance to CABO/ANSI A117.1-1992
- IAPMO Listed
- CSA Certified
- ASTM F409 (for non-metallic drain)

STANDARD SPECIFICATIONS:



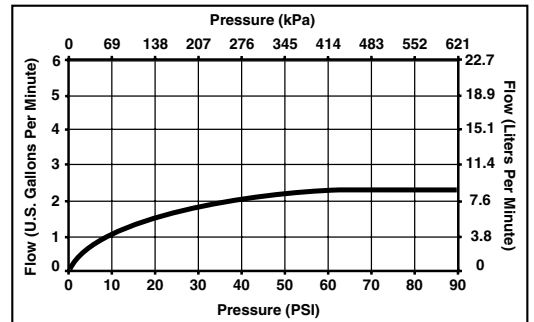
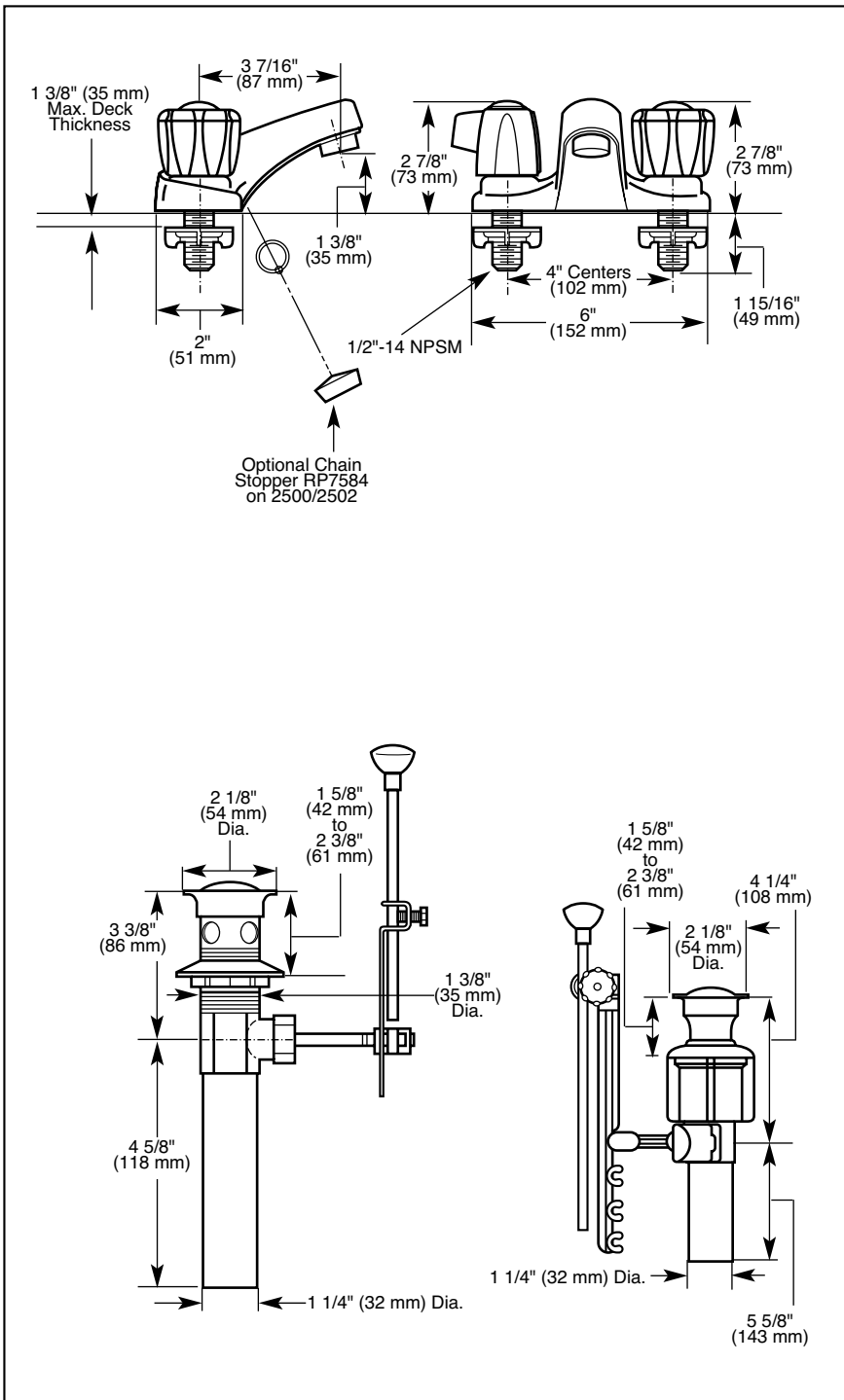



- Two handle lavatory deck faucets for exposed mounting on two and three hole sinks.
- 4" (102 mm) centerset.
- Solid brass fabricated body.
- 3 7/16" (87 mm) long spout.
- Hot and cold stems are interchangeable.
- Control mechanism shall be of the rotating cylinder type with stainless steel plate and 180° rotation, with replaceable non-metallic seats operating in stainless steel lined sockets.
- 1/2"-14 NPSM threaded male inlet shanks.
- Models with Snap-N-Pop-Up® drain have polypropylene pop-up type fitting with plated flange and stopper.
- Models with metal drain have pop-up type fitting with plated flange and stopper.



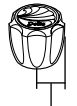
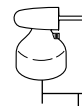

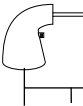

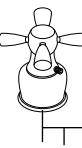



Delta reserves the right (1) to make changes in specifications and materials, and (2) to change or discontinue models, both without notice or obligation. Dimensions are for reference only.

Standard Features	2500			2522				
	2500	2520	2520-MPU	2502	2522	2522-MPU	2522-PB	2522-WH
Washerless	◆	◆	◆	◆	◆	◆	◆	◆
Two Hole Installation	◆			◆				
Three Hole Installation	◆	◆	◆	◆	◆	◆	◆	◆
4" (102 mm) Centerset	◆	◆	◆	◆	◆	◆	◆	◆
3 7/16" (87 mm) Long Spout	◆	◆	◆	◆	◆	◆	◆	◆
ABS Blade Handles (H28)	♿	♿	♿					
Clear Knob Handles with Red/Blue Indicators (H21)				◆	◆	◆	◆	◆
Notched Undercover Plate to Accept RP7584 Chain and Stopper	◆			◆				
Capped Lift Rod Hole	◆			◆				
1/2"-14 NPSM Threaded Male Inlet Shanks	◆	◆	◆	◆	◆	◆	◆	◆
Snap-N-Pop-Up® Drain		◆			◆			
Metal Pop-Up Drain			◆			◆	◆	◆
No Pop-Up Drain	◆			◆				
Chrome Finish	◆	◆	◆	◆	◆	◆		
<i>Brilliance</i> ™ Polished Brass Finish							◆	
White Finish								◆

***Available LHP Handle Options**

<p>H21</p>  <p>1" (25 mm)</p>	<p>H22</p>  <p>2 1/2" (64 mm)</p> <p>A22</p> <p>♿</p>	<p>H23</p>  <p>1" (25 mm)</p> <p>A23</p>	<p>H24</p>  <p>3 1/4" (83 mm)</p> <p>A24</p> <p>♿</p>
<p>H25</p>  <p>2 1/2" (64 mm)</p> <p>♿</p>	<p>H26</p>  <p>1 1/4" (32 mm)</p> <p>♿</p>	<p>H27</p>  <p>1 1/4" (32 mm)</p> <p>♿</p>	<p>H28</p>  <p>1 7/16" (37 mm)</p> <p>♿</p>

***Available LHP Handle Accent Options with Matching Lift Knobs**

 A22CL	 A24CL
 A22, A22AL, A22PB, A22WH	 A24, A24AL, A24PB, A24WH
 A22PR	 A23ST
 A22OK, A22RS, A22WW	 A23OK
 A23, A23AL, A23PB, A23WH	



Indianapolis, Indiana 46280
A Division of Masco Corporation of Indiana
© 2001 Masco Corporation of Indiana