



- G1902HFC** Safety Station with Eyewash, Hand and Foot Control, Stainless Steel Bowl
- G1902P-HFC** Safety Station with Eyewash, Hand and Foot Control, Plastic Bowl

APPLICATION: Combination eyewash and shower safety station. Eyewash is activated by flag handle or foot treadle. Two GS-Plus™ spray-type outlet heads deliver a flood of water for rinsing eyes.

SHOWER HEAD: 10" diameter orange ABS plastic.

SHOWER VALVE: 1" IPS chrome plated brass stay-open ball valve. Valve is US-made with chrome plated brass ball and Teflon® seals. Furnished with stainless steel actuating arm and 29" stainless steel pull rod.

SPRAY HEAD ASSEMBLY: Two GS-Plus™ spray heads. Each head has a "flip top" dust cover, internal flow control and filter to remove impurities from the water flow.

EYEWASH BOWL: 11 1/2" diameter. Bowl is stainless steel (G1902HFC) or orange ABS plastic (G1902P-HFC).

EYEWASH VALVE: 1/2" IPS chrome plated brass stay-open ball valve. Valve is US-made with chrome plated brass ball and Teflon® seals. Valve is activated by flag handle or foot treadle. Unit remains in operation until handle is returned to closed position.

PIPE AND FITTINGS: Schedule 40 galvanized steel. Furnished with orange polyethylene covers for vertical piping for high visibility and corrosion resistance.

SUPPLY: 1 1/4" NPT female top or side inlet.

WASTE: 1 1/4" NPT female outlet.

SIGN: Furnished with ANSI-compliant identification sign.

QUALITY ASSURANCE: Valve and spray head assemblies are factory assembled and water tested prior to shipment.

Available Options

- GC** Powder coated finish on galvanized pipe and fittings. Available colors include orange, yellow, red and green.
- FC20** Regulates shower flow rate to 20 GPM.
- GRN** Green ABS plastic shower head.
- YEL** Yellow ABS plastic shower head.
- SSH** Stainless steel shower head.
- AP275-100 ELECTRIC LIGHT AND ALARM HORN**
Light and alarm horn summon assistance when eyewash or shower is activated.
- AP250-015 MODESTY CURTAIN**
Modesty curtain for mounting on safety station.
- TMV** G3800 thermostatic mixing valve precisely blends hot and cold water to deliver warm (tepid) water as required by ANSI Z358.1-2004.





□ **G1902HFC** Safety Station with Eyewash, Hand and Foot Control, Stainless Steel Bowl

□ **G1902P-HFC** Safety Station with Eyewash, Hand and Foot Control, Plastic Bowl

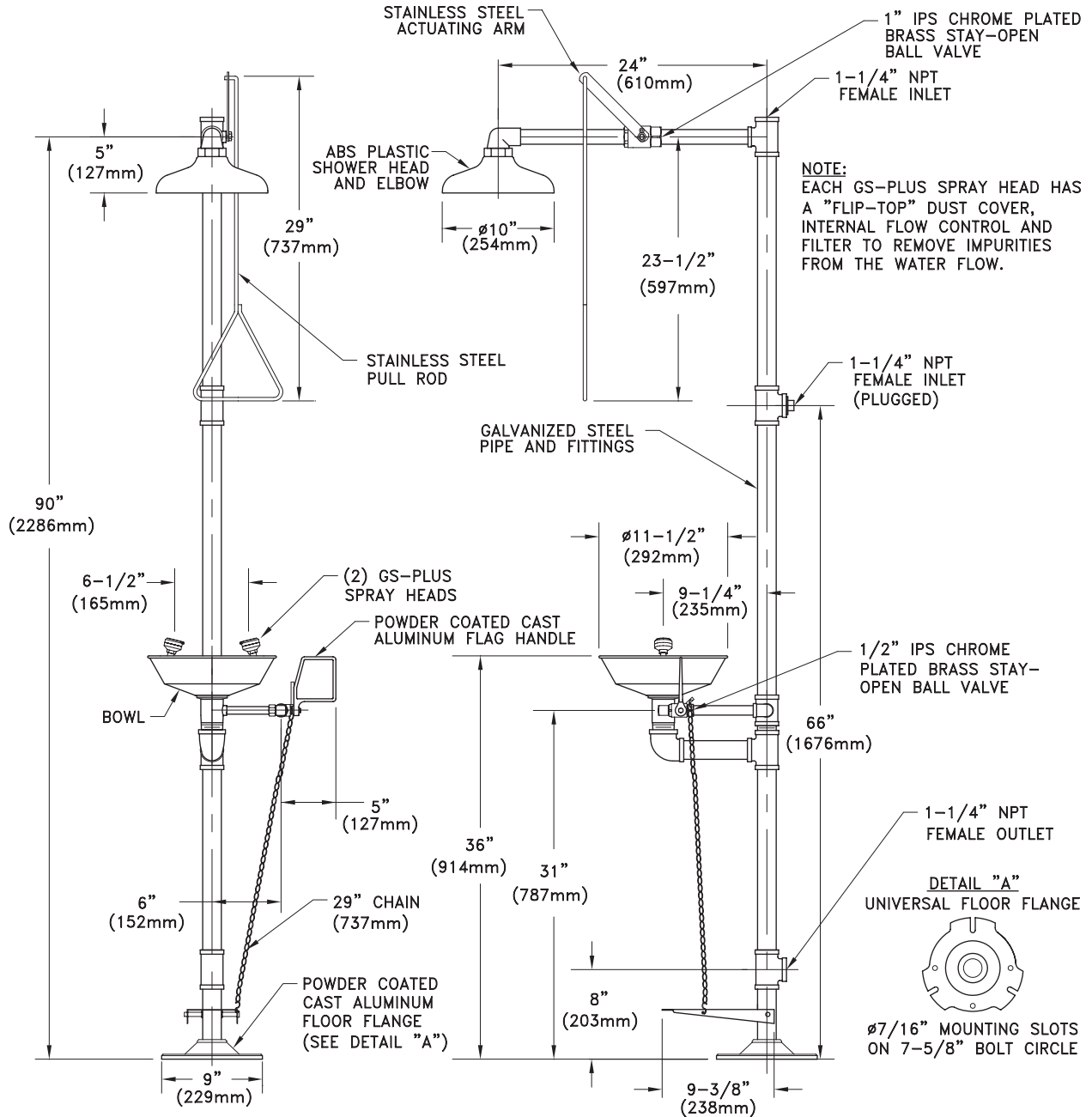

THIS SPACE FOR ARCHITECT/ENGINEER APPROVAL

Due to continuing product improvement, the information contained in this document is subject to change without notice. All dimensions are ± 1/4" (6mm). rev. 0308

Sign Included

